



KB6W Digital Piano 88-key with Furniture Stand

Ref. nr.: 130.098



INSTRUCTION MANUAL

Congratulations to the purchase of this MAX Music product. Please read this manual thoroughly prior to using the product in order to benefit fully from all features.

Read the manual prior to using the product. Follow the instructions in order not to invalidate the warranty. Take all precautions to avoid fire and/or electrical shock. Repairs must only be carried out by a qualified technician in order to avoid electrical shock. Keep the manual for future reference.

- Prior to using the product, please ask advice from a specialist. When the unit is switched on for the first time, some smell may occur. This is normal and will disappear after a while.
- The unit contains voltage carrying parts. Therefore do NOT open the housing.
- Do not place metal objects or pour liquids into the product. This may cause electrical shock and malfunction.
- Do not place the product near heat sources such as radiators, etc. Do not place the unit on a vibrating surface. Do not cover the ventilation holes.
- The product is not suitable for continuous use.
- Be careful with the mains lead and do not damage it. A faulty or damaged mains lead can cause electrical shock and malfunction.
- When unplugging the product from a mains outlet, always pull the plug, never the lead.
- Do not plug or unplug the unit with wet hands.
- If the plug and/or the mains lead are damaged, they need to be replaced by a qualified technician.
- If the product is damaged to such an extent that internal parts are visible, do NOT plug the unit into a mains outlet and DO NOT switch the product on. Contact your dealer. Do NOT connect the product to a rheostat or dimmer.
- To avoid fire and shock hazard, do not expose the product to rain and moisture.
- All repairs should be carried out by a qualified technician only.
- Connect the product to an earthed mains outlet (220-240Vac/50Hz) protected by a 10-16A fuse.
- During a thunderstorm or if the product will not be used for a longer period of time, unplug it from the mains. The rule is: Unplug it from the mains when not in use.
- If the product has not been used for a longer period of time, condensation may occur. Let the unit reach room temperature before you switch it on. Never use the product in humid rooms or outdoors.
- During operation, the housing may become hot.
- To prevent accidents in companies, you must follow the applicable guide lines and follow the instructions.
- Do not repeatedly switch the product on and off. This shortens the life time.
- Keep the unit out of the reach of children. Do not leave the unit unattended.
- Do not use cleaning sprays to clean switches. The residues of these sprays cause deposits of dust and grease. In case of malfunction, always seek advice from a specialist.
- Only operate the product with clean hands.
- Do not force the controls.
- If the product has fallen, always have it checked by a qualified technician before you switch the product on again.
- Do not use chemicals to clean the unit. They damage the varnish. Only clean the product with a dry cloth.
- Keep away from electronic equipment that may cause interference.
- Only use original spares for repairs, otherwise serious damage and/or dangerous radiation may occur.
- Switch the product off prior to unplugging it from the mains and/or other equipment. Unplug all leads and cables prior to moving the product.
- Make sure that the mains lead cannot be damaged when people walk on it. Check the mains lead before every use for damages and faults!
- The mains voltage is 220-240Vac/50Hz. Check if power outlet match. If you travel, make sure that the mains voltage of the country is suitable for this product.
- Keep the original packing material so that you can transport the product in safe conditions



This mark attracts the attention of the user to high voltages that are present inside the housing and that are of sufficient magnitude to cause a shock hazard.



This mark attracts the attention of the user to important instructions that are contained in the manual and that he should read and adhere to.

The product has been certified CE. It is prohibited to make any changes to the product. They would invalidate the CE certificate and their guarantee!

NOTE: To make sure that the unit will function normally, it must be used in rooms with a temperature between 5°C/41°F and 35°C/95°F.



Electric products must not be put into household waste. Please bring them to a recycling centre. Ask your local authorities or your dealer about the way to proceed. The specifications are typical. The actual values can slightly change from one unit to the other. Specifications can be changed without prior notice.

Do not attempt to make any repairs yourself. This would invalid your warranty. Do not make any changes to the product. This would also invalid your warranty. The warranty is not applicable in case of accidents or damages caused by inappropriate use or disrespect of the warnings contained in this manual. Max cannot be held responsible for personal injuries caused by a disrespect of the safety recommendations and warnings. This is also applicable to all damages in whatever form.

UNPACKING INSTRUCTION

CAUTION! Immediately upon receiving the product, carefully unpack the carton, check the contents to ensure that all parts are present and have been received in good condition. Notify the shipper immediately and retain packing material for inspection if any parts appear damaged from shipping or the package itself shows signs of mishandling. Save the package and all packing materials. If the product must be returned to the factory, it is important that the product is returned in the original factory box and packing.

If the device has been exposed to drastic temperature fluctuation (e.g. after transportation), do not switch it on immediately. The arising condensation water might damage your device. Leave the device switched off until it has reached room temperature.

Supplied contents:

- MAX Music KB6 keyboard / electronic piano
- Power supply
- Music sheet stand
- Sustain pedal

POWERSUPPLY

The label on the bottom of the product indicates to what type of power supply the product must be connected. Check that the mains voltage corresponds to this, all other voltages may cause irreparable damage. The product must also be directly connected to the mains, no dimmer or adjustable power supply.



Always connect the device to a protected circuit (circuit breaker or fuse). Make sure the device has an appropriate electrical ground to avoid the risk of electrocution or fire.

ASSEMBLY INSTRUCTIONS

Furniture assembly contents:

- | | | | | | |
|----|--|------------------------|----|--|--------------------|
| 2x | | ① M5 screw | 4x | | ④ M6 nut |
| 2x | | ② Iron bracket (angle) | 4x | | ⑤ M6 screw (long) |
| 4x | | ③ M6 screw (short) | 4x | | ⑥ M5 plastic screw |

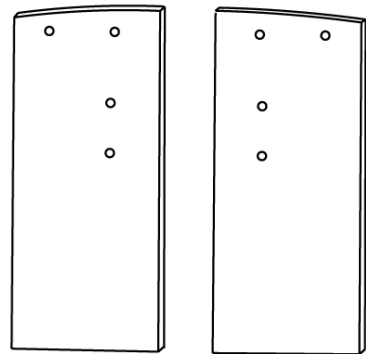
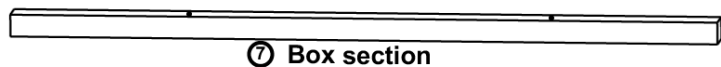

Please install the wooden frames according to the following diagrams.

1. Install box section: Slot the box section ⑦ into the groove on the bottom of the piano and tighten it with M5 screws ①.

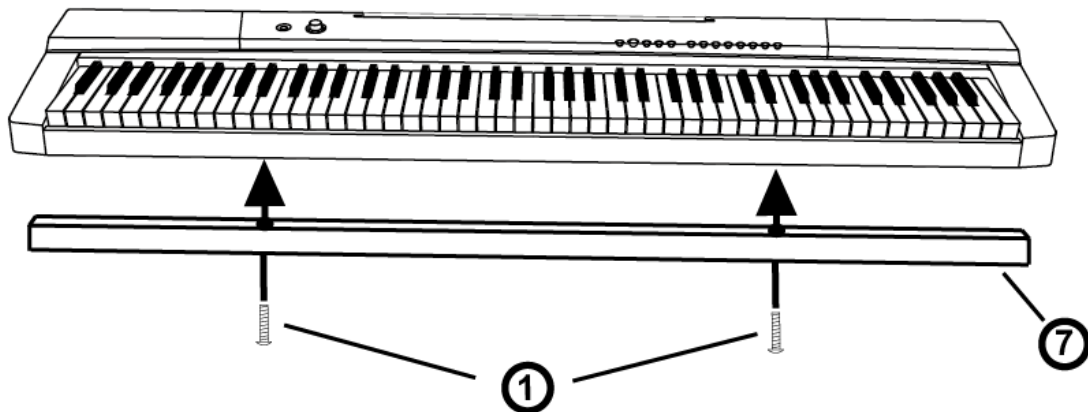

- Installation of angled iron brackets: Install the iron brackets on the left and right baseboard ⑨ & ⑩. Tighten them with M6 short screws.

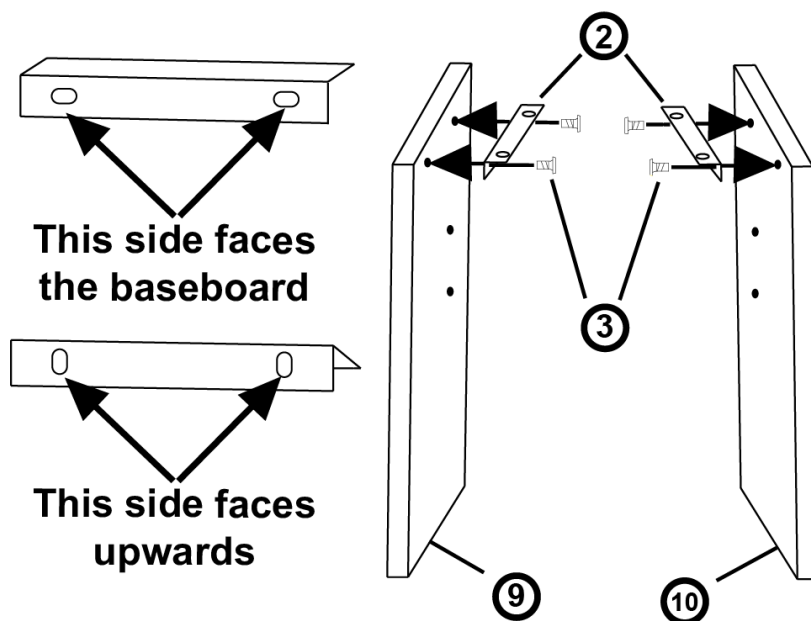

- Install the Rung ⑧: Make sure the perforated side of the rung is facing inside. Insert the M6 nut ④ in the indicated holes (adjust the nut to fit the side entry holes perfectly). Secure the rung with M6 long screws ⑤ from the baseboard side.

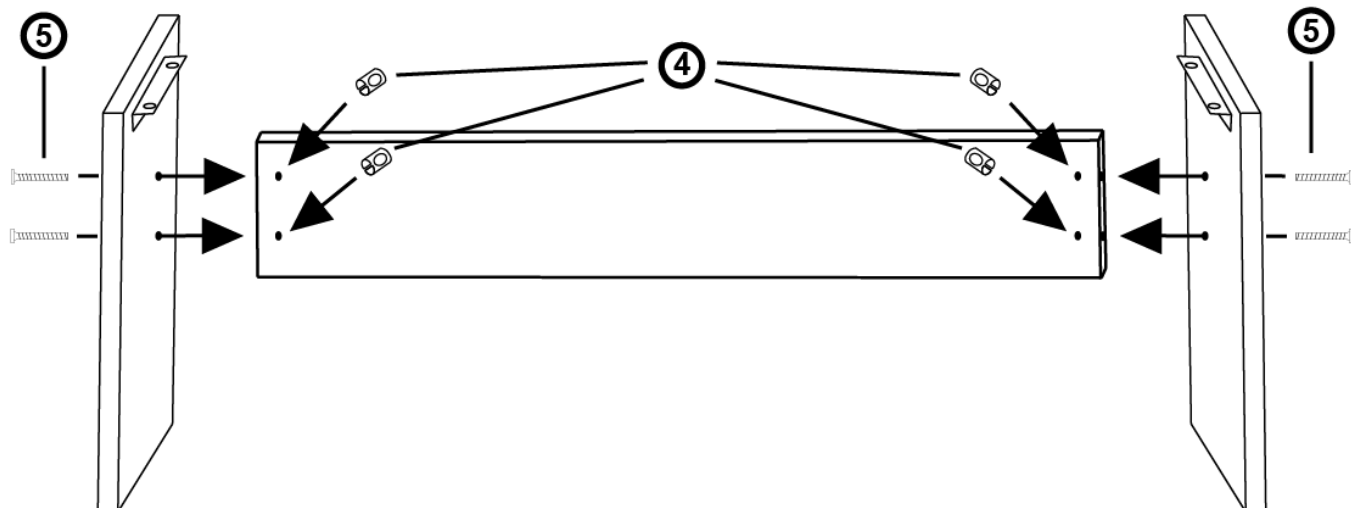

- Piano installation: Place the piano on the top of the wooden frame and lock the piano with M5 plastic screws ⑥.

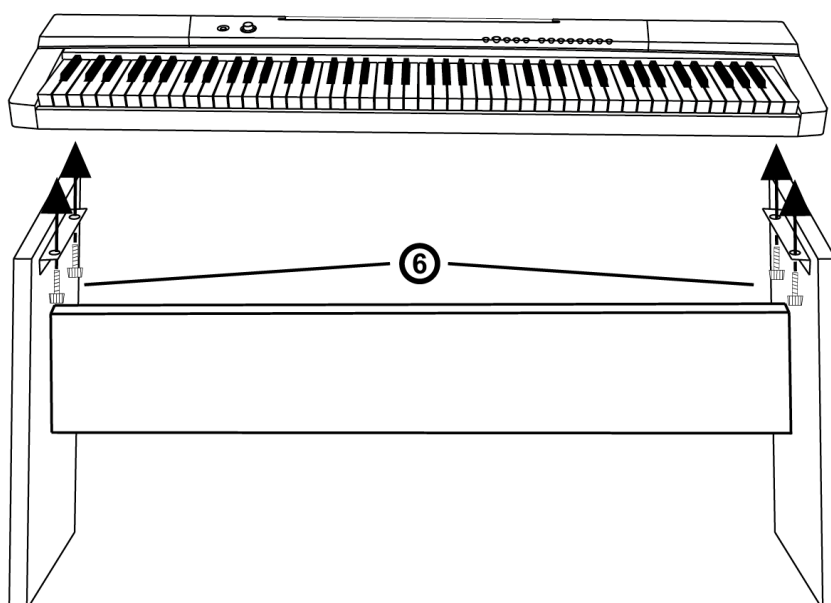

DEFAULT CONTROLS

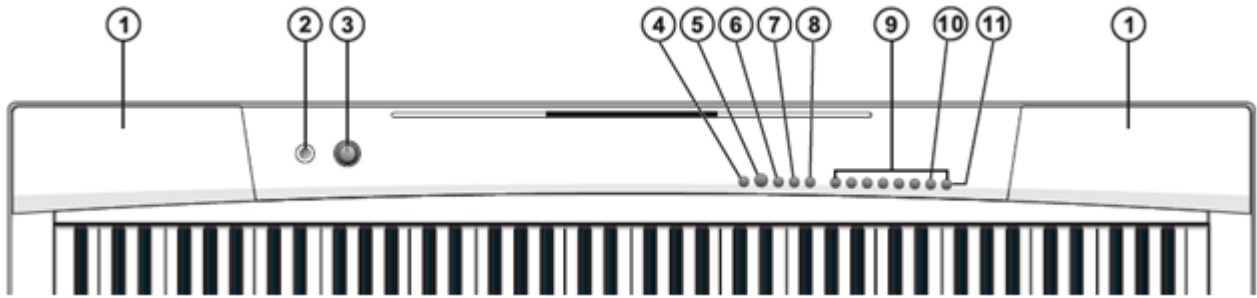

1. **SPEAKERS**
Loudspeakers to reproduce the sound of the music played. Sound level is determined on the basis of the volume setting.
2. **POWER ON/OFF**
Switch to turn the piano on or off.
3. **MASTER VOLUME**
Turn the knob to raise (clockwise) or lower (counter-clockwise) the master volume.
4. **FUNCTION**
Press and hold this button to form different combinations with other buttons/keys, allowing various functions to be unlocked. Read more about how to exploit the potential of this button further down the manual.
5. **DEMO**
This piano has 16 stored demo songs ("00" to "15") for your selection. Press [DEMO] and the demo songs will start to play in order. During playing process, press [DEMO] to stop playing the selected demo song. Press the [FUNCTION+] button + enter a 2-digit code by the designated keys to select the corresponding demo song.

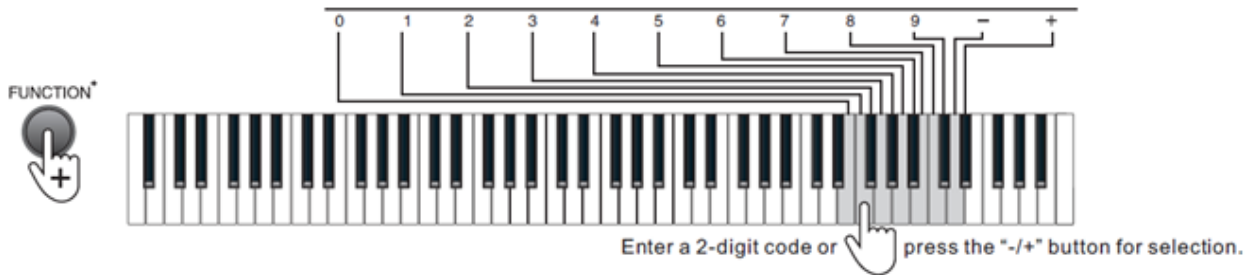

6. **METRONOME**
There are 10 tempos stored on the piano, ranging between 1/4 beat to 12/8 beat. Press [METRONOME] to activate the metronome, press again to deactivate. Press [FUNCTION +] + the 1/4~12/8 keys to set the desired metronome.

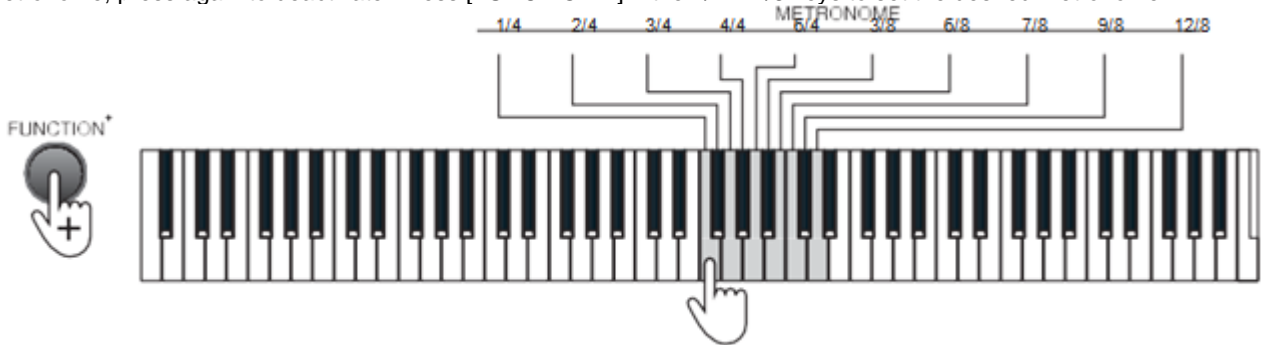

7. LESSON

In lesson mode, the 88 keys are split into two zones with identical tone and timbre, which facilitates the demonstration by teacher-level students, and two people can play the piano simultaneously. Press the [LESSON] button to activate the lesson mode and press the [LESSON] button again to disable this function.

Using the lesson mode, the scales of Keys A0 - C5 in the left zone will change to the scales of Keys A2 - C6, while the scales of Keys C4# - C8 in the right zone will change to the scales of Keys C2# - C6.

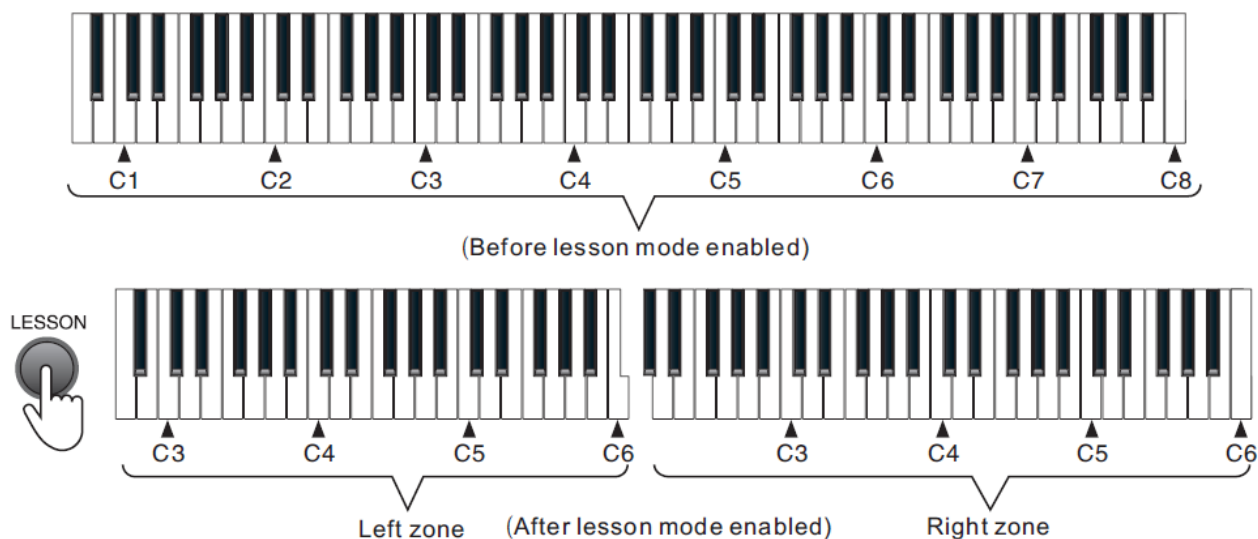

8. SPLIT

The piano can be split into two zones, in this way, you can play two different timbres with your left and right hands respectively. You should set the timbre for the right hand side after the timbre that you were using before splitting is applied to the left-hand side. For example, you can set the timbre of the left-hand side to bass and the right-hand side to piano. Press the [SPLIT+] button to split the piano, and press the [SPLIT+] button again to disable the piano split. Press the [SPLIT+] button for the first time and press the key simultaneously to set the split point. The currently pressed key will be the first key of the right-hand side.

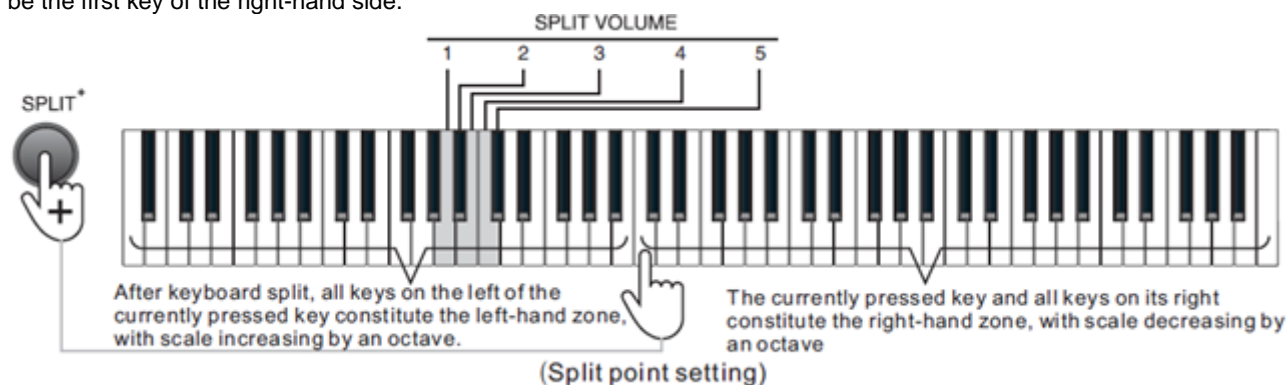

When the piano split function is enabled, the scale of the left-hand zone will increase by an octave, and the scale of the right-hand zone will decrease by an octave. Take the default split point as an example, scales of Keys A0 – G2 # will change to those of Keys A1 – G3#, while scales of Keys A2 – C8 will change to those of Keys A1 – C7.

Press the [FUNCTION+] button and [SPLIT] 1-5 keys to set the volume for the left-hand zone.

After the piano split function is enabled, you can reselect a timbre for the right-hand zone.

9. TIMBRE

This piano provides 140 timbres ("000" to "139") for your selection. Eight different default timbres are also provided.

To select timbres: Press the [GM TIMBRE] button + [DEMO SONG/GM TIMBRE] keys to select a timbre. Or press the "+/-" for selection.

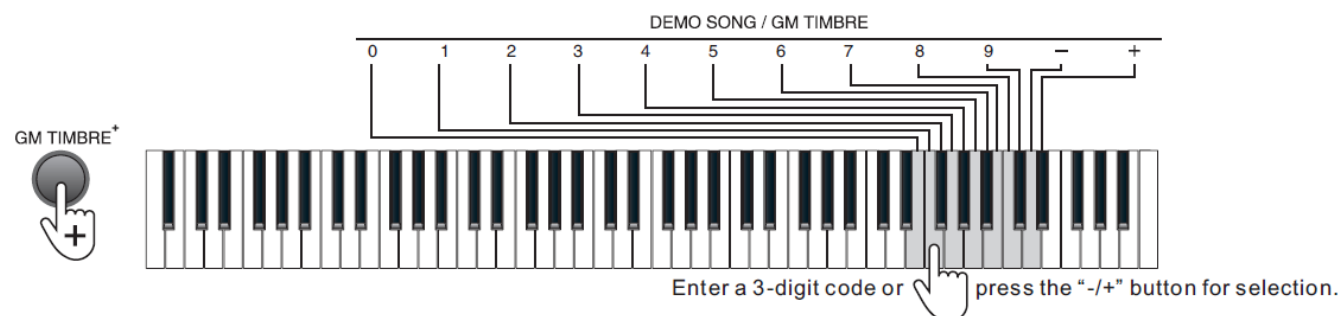

DUAL TIMBRE

Press any two timbre buttons simultaneously to enable the dual timbre function. This will ensure the two selected timbre are overlaid.

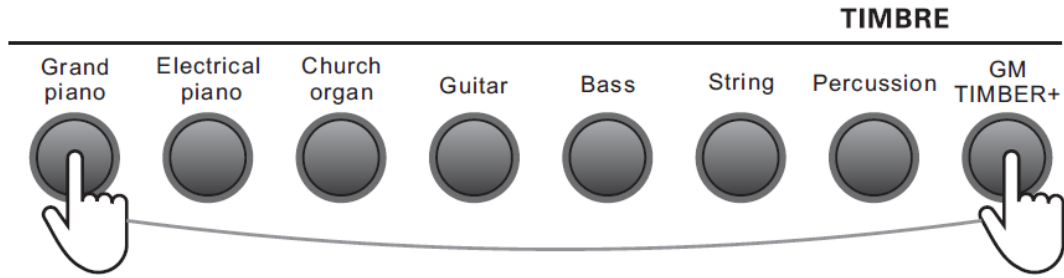

When overlay of other timbres is required, press the [GM TIMBRE] button + the [DEMO SONG/GM TIMBRE] key to select other timbres, and then press the [GM TIMBRE] and other [TIMBRE] buttons simultaneously.

Both volumes for the upper layer and the lower layer have 5 levels: the volume of the first selected timbre is adjusted via the upper volume by pressing the [FUNCTION+] button + the [UPPER VOLUME 1 - 5] keys on the piano. Volume of the later selected timbre is adjusted via the lower volume by pressing the [FUNCTION+] button + the [LOWER VOLUME 1 - 5] keys.

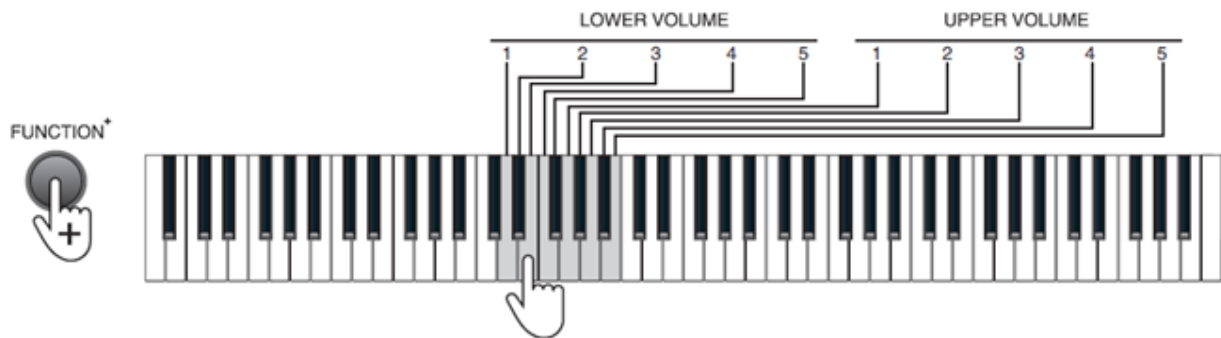

10. PERCUSSION

This Piano provides multiple percussions. Press [PERCUSSION] to turn the piano into percussion piano, and each key corresponds to one percussion instrument. Press this button again to disenable the piano percussion function.

11. GM TIMBRE

This button is designated (single press) for the default timbre of "088 Pad 1 (New Age)". Press the [GM TIMBRE] button + enter a 3-digit code to select a timbre, ranging from "000" to "139".

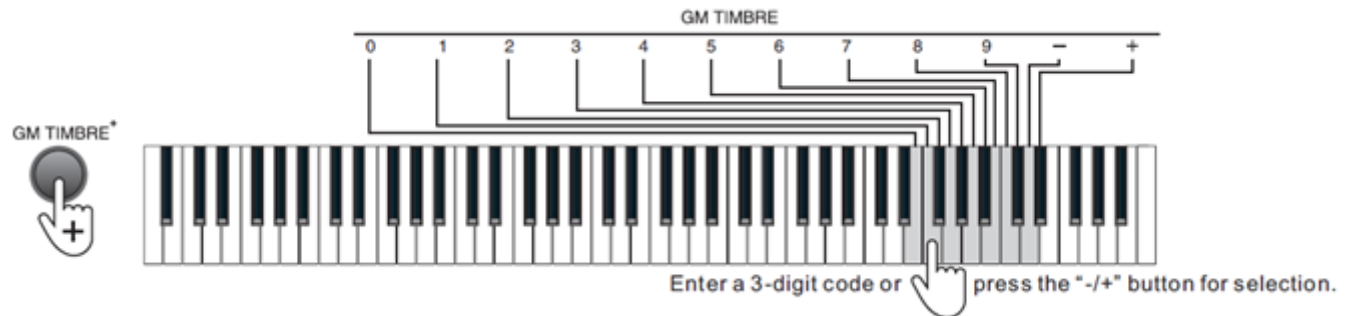

KEY CONTROLS

The following functions are activated by combining the (4) [FUNCTION] or (11) [GM TIMBRE] button and the appointed key as numbered below.

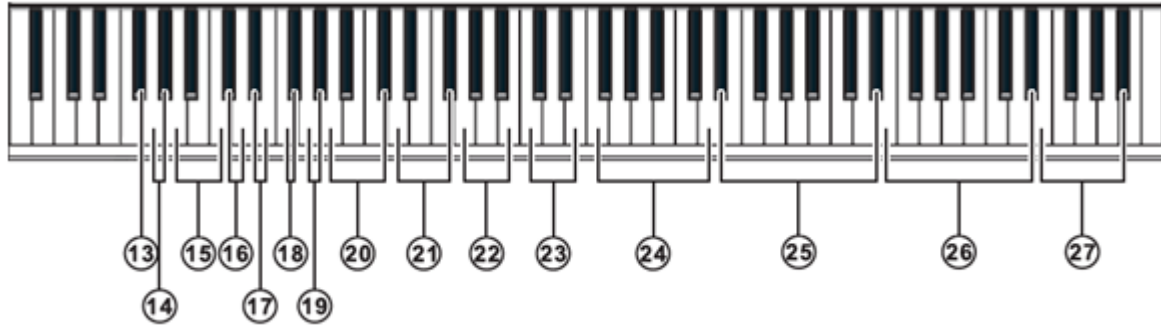

- | | | | |
|-------------|------------------|----------------------|------------------------|
| ④+⑬ Click | ④+⑰ Vibrato | ④+⑳ Lower Volume | ④+㉕ Tempo |
| ④+⑭ Record | ④+⑱ Transpose | ④+㉑ Upper Volume | ④+㉖ Demo Song |
| ④+⑮ Touch | ④+⑲ Octave | ④+㉒ Metronome Volume | ⑪+㉖ GM Timbre Select |
| ④+⑯ Sustain | ④+㉐ Split Volume | ④+㉓ Metronome | ④+㉗ Udisk Music Player |

13. KEY TONE

The "key tone" or "click" function is defaulted to be enabled. Press the [FUNCTION+] button + the designated "13" key on the piano to enable or disable the function. A prompt clicking tone will be emitted.

14. RECORD

Press the [FUNCTION+] button + the record key to enable the record mode. Press the [FUNCTION+] button + the record key again to disable the record mode. Using the record mode, the metronome will be enabled automatically and you can press any key to start recording. Press the [FUNCTION+] button + the [TEMPO] key to adjust the tempo.

This piano can record a maximum of 700 notes. When the storage memory is full, the record mode will be disabled and the metronome will shut down automatically.

15. TOUCH

Press the [FUNCTION+] button + [TOUCH] OFF or one of the 1-3 keys to turn off or shift touch force between 3 grades.

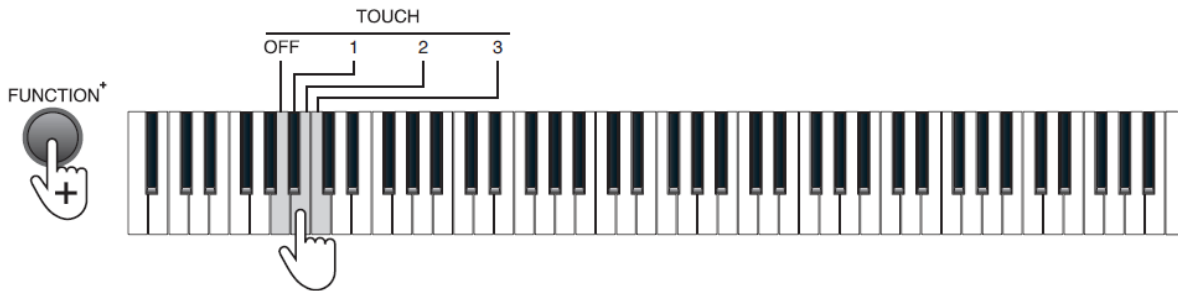

16. SUSTAIN AND 17. VIBRATO

Sustain: prolong the lasting time of a pitch.

Press the [FUNCTION+] button + the [SUSTAIN - ON] key to enable the sustain effect.

Press the [FUNCTION+] button + the [SUSTAIN - OFF] key to disable the sustain effect.

Vibrato: add a pulsating change to the pitch

Press the [FUNCTION+] button + the [VIBRATO - ON] key to enable the vibrato effect.

Press the [FUNCTION+] button + the [VIBRATO - OFF] key to disable the vibrato effect.

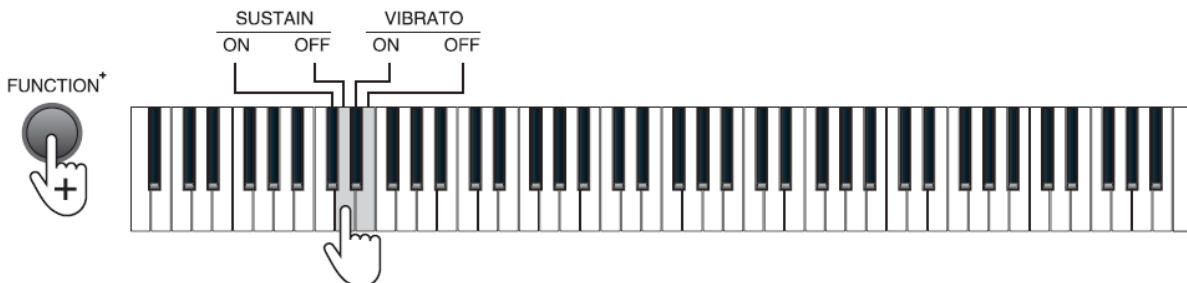

18. TRANSPOSE

The transpose control function of the piano is adjustable from “-6” to “+6”, and the default setting is 0. Press the [FUNCTION+] button + the [TRANSPOSE- /+] keys for transposing within ± 6 .



The transpose function saves the trouble of raising and lowering the key when playing on the piano. You can play songs in every key in the same way as that for playing songs in key C. It may decrease the key by half-step (minor second), thus the keys positions for key C is changed to those for key B. Press the “+” button increase all keys by half-step (minor second), in this case, the tone of the key position of key C is changed to key C# or key D \flat . If the button is pressed for twice, buttons simultaneously to reset key C.

19. OCTAVE

Note: Octave control can only be enabled under the lesson mode.

When lesson mode is enabled, you can perform octave adjustment from “-2” to “+2”. Default setting is 0. Press the [FUNCTION+] button + the [OCTAVE] “-” / “+” keys for octave adjustment within ± 2 . For example, when adjusting octave to “-2”, the left zone will change to A0-C4 while the right zone will change to C0#-C4. Press the [FUNCTION+] button + [OCTAVE] “-” / “+” keys simultaneously to restore the default setting.

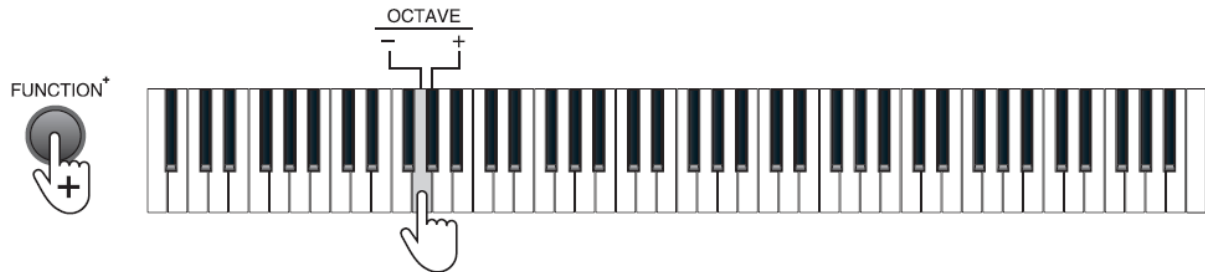

20. SPLIT VOLUME

Press the [FUNCTION+] button and one of the 1-5 keys to set the volume for the left-hand zone.

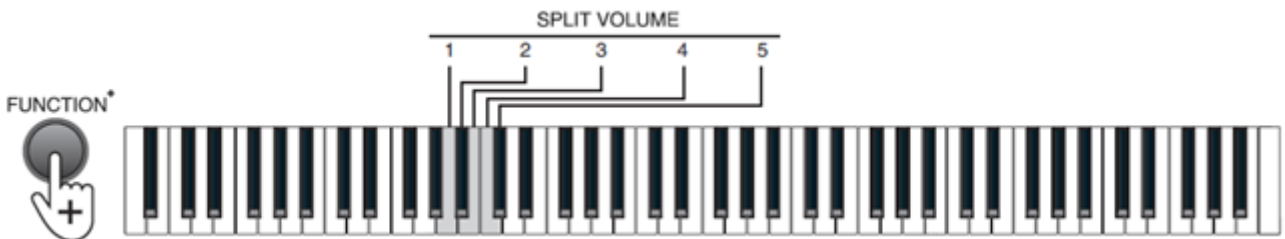

21. LOWER VOLUME AND 22. UPPER VOLUME

When an overlay of multiple timbres has been initiated: the volumes for the upper layer and the lower layer have 5 levels: the volume of the first selected timbre is adjusted via the upper volume by pressing the [FUNCTION+] button + the [UPPER VOLUME 1 - 5] keys on the piano. Volume of the later selected timbre is adjusted via the lower volume by

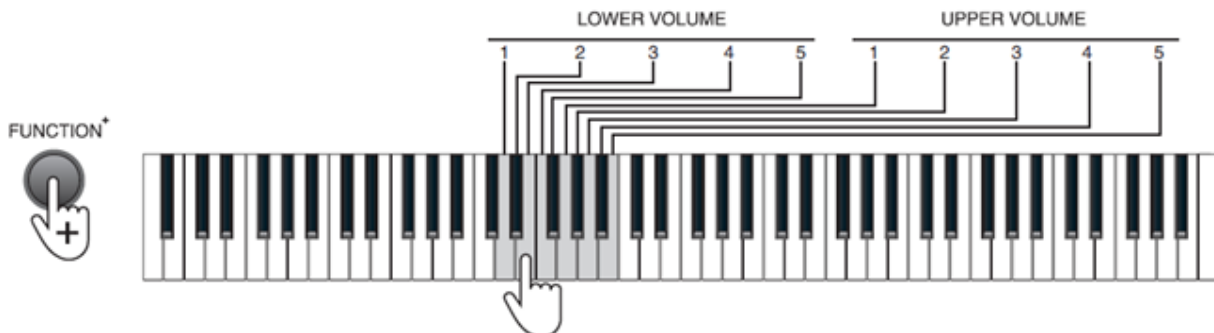

pressing the [FUNCTION+] button + the [LOWER VOLUME 1 - 5] keys.

23. METRONOME VOLUME

This piano is equipped with 5 metronome volumes. Press the [FUNCTION+] button + the [METRONOME VOLUME] 1 - 5 keys for metronome volume setting.

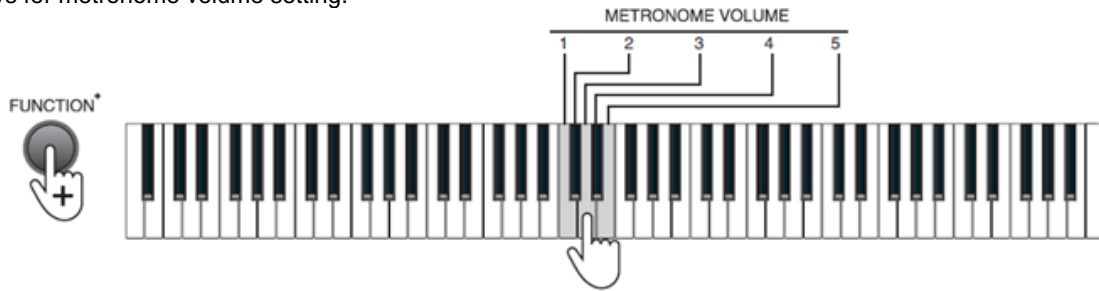

24. METRONOME

There are 10 tempos stored on the piano, ranging between 1/4 beat to 12/8 beat. Press [METRONOME] to activate the metronome, press again to deactivate. Press [FUNCTION+] + the 1/4-12/8 keys to set the desired metronome.

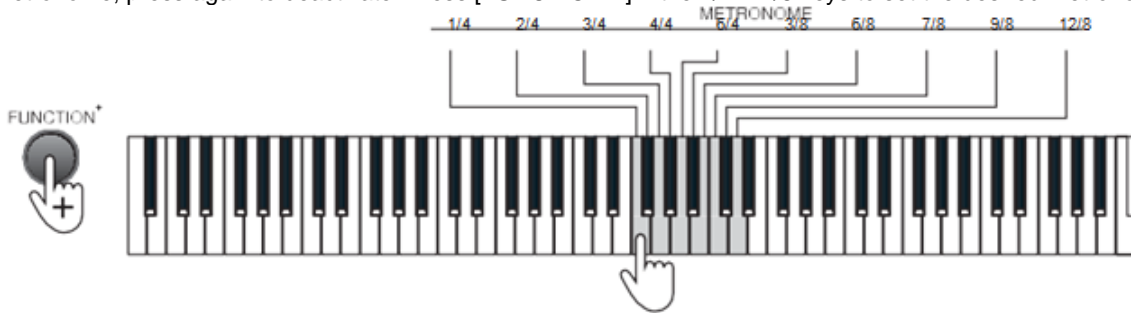

25. TEMPO

The tempo is defaulted to be 120, but is adjustable between the range of "30" to "300". Press the [FUNCTION+] button + [Tempo] number + "-/+ " keys to select the required tempo. Press the [FUNCTION+] button + the [TAP] key of the [TEMPO] to reset to default value.

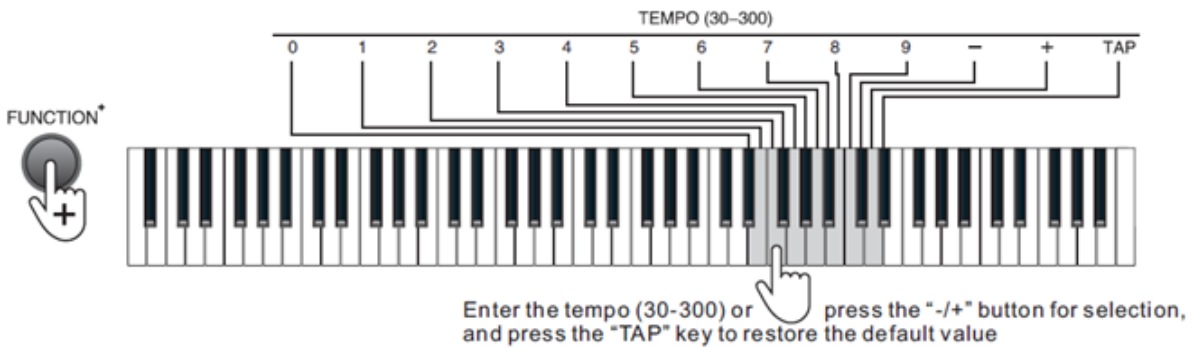

26. DEMO

This piano has 16 stored demo songs ("00" to "15") for your selection. Press [DEMO] and the demo songs will start to play in order. During playing process, press [DEMO] to stop playing the selected demo song. Press the [FUNCTION+] button + enter a 2-digit code by the designated keys to select the corresponding demo song.

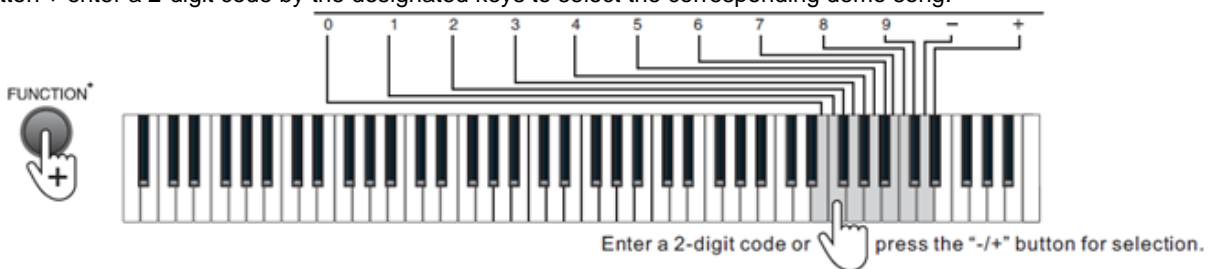

26. TIMBRE SELECT

Press the [GM TIMBRE] button + enter a 3-digit code to select a timbre, ranging from "000" to "139". Or press the "+/-" for selection.

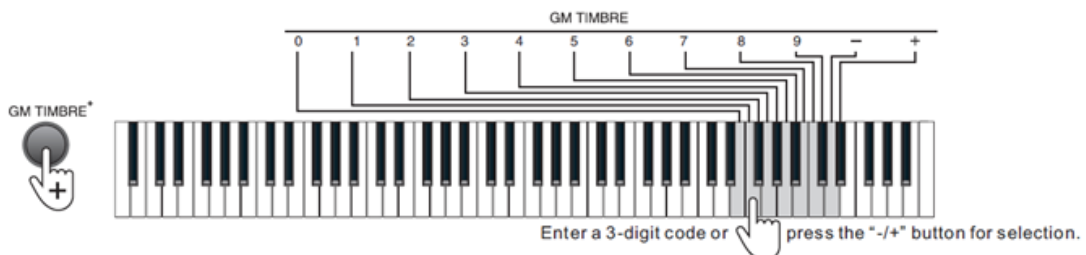

27. UDISK MEDIA PLAYER

The piano has an in-built U disk music player with 32G memory, which can be used to play music of MP3 format. Insert a U disk into the UDISK port on the rear panel, press the [FUNCTION+] + UDISK MUSIC PLAYER [ON/OFF] buttons to play MP3 music.

- Press the [FUNCTION+] + UDISK MUSIC PLAYER [▶||] buttons to play or pause a track.
- Press the [FUNCTION+] + UDISK MUSIC PLAYER [-||| +] buttons to adjust the volume.
- Press the [FUNCTION+] + [I◀◀] or [▶▶I] buttons to go to the previous or next track.
- Press the [FUNCTION+] + [↻/X/↻] buttons to cycle through the repeat modes for continuous, random, or single playback.
- Press the [FUNCTION+] + UDISK MUSIC PLAYER [ON/OFF] buttons again to deactivate the MP3 music playing function.

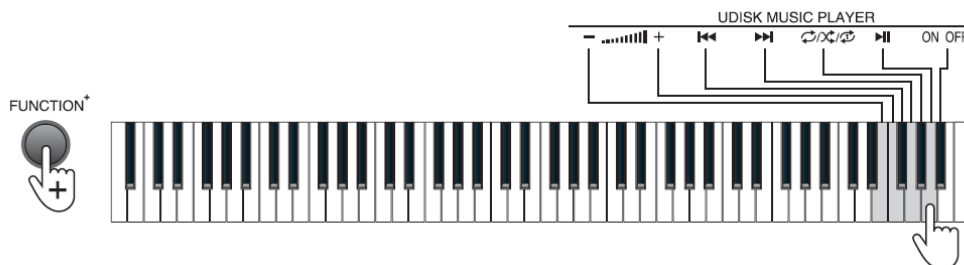

CONNECTIONS

1. POWER ADAPTER INPUT

Use only the supplied power adapter. Connect the output end of the adapter to the power port located on the rear panel of the piano and make sure to then connect the plug with the mains socket. Note: power point's voltage needs to be compatible with the power supply used.

2. HEADPHONES

This model is equipped with two 6.5mm dual-track headphone ports. When connecting headphones to the PHONES-1 or PHONES-2 ports on the rear panel of the piano, the loudspeaker will be disabled automatically. This is to ensure that the sound is channelled to the headphones and does not disturb other individuals in the area.

Caution! When using headphones maintain the volume at an appropriate level to protect your hearing.

3. AUDIO OUT

This piano is configured with an in-built loudspeaker. You may connect it to other external audio devices. Firstly, turn off the piano and the external audio device. Secondly, connect one end of the audio cable to the AUDIO OUT (audio output) port on the rear panel of the piano, and finally connect the other end to the audio input port of the audio device.

4. AUDIO IN

The piano is equipped with a stereo input function. Sound signals from mobile phone, MP3 player, computer and other audio devices can be played through the speakers of the piano. Firstly, turn off the piano. Secondly, connect one end of the audio cable to the output port of an audio device, and the other end to the AUDIO IN port on the rear panel of the piano. Finally, turn on the piano.

5. PEDAL

The piano is configured with a 3-in-1 pedal port which can be used for the connection of a sustain. Connect the pedal connector to the PEDAL port on the rear panel of the piano, and carry out required operations with the pedal.

6. USB-MIDI

The USB-MIDI (APP) port of the piano is used for the connection with a mobile phone or a tablet. Download and install a relevant APP to use this feature. Apps are not supplied with these units. A dedicated OTG data cable for the piano should be used to connect the unit to a PC or tablet. The USB-MIDI (APP) port of the piano can also be used to connect the unit to other musical instruments, computers and MIDI.

7. UDISK

The piano has an in-built U disk music player with 32G memory, which can be used to play music of MP3 format. For further information on how to operate, please see "27. UDISK MEDIA PLAYER".

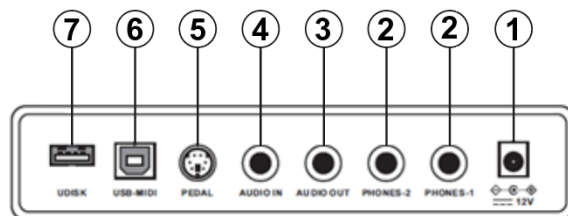

RECOMMENDED TRAINING APPS / GAMES

MAX highly recommends the below apps to support you on your journey of piano exploration. It has never been this easy to dip your toes in the deep and majestic waters of playing the piano. Train yourself from novice to king of the keys with help from **PIANO DUST BUSTER**, **PIANO MAESTRO** and **SIMPLY PIANO**.

Please note: downloading the below apps is free of charge. Expanding the apps with more training, songs and other additives might involve costs.



PIANO DUST BUSTER

PIANO DUST BUSTER is the ultimate introduction to piano for kids. No previous piano experience needed!



PIANO MAESTRO

An in depth educational tool to study piano. From a single note to complete pieces, **PIANO MAESTRO** makes sheet music come to life!



SIMPLY PIANO

Explore the piano step-by-step, from scratch. **SIMPLY PIANO** will help you learn the basics from sight-reading to playing with both hands.

PIANO DUST BUSTER

Help granny dusting off her piano while collecting points and bonuses. Piano Dust Buster is a great tool to get excited about playing your piano and improving your skills. Piano Dust Buster is an ultimate introduction to piano, no previous piano experience needed. You have the option to begin practicing reading notation, compete against other players or challenge yourself to hundreds of songs ranging from Beethoven to Adele. (*IOS compatible only!)



PIANO MAESTRO

#1 ranked Education App. An in depth educational tool for beginning to study piano. PIANO MAESTRO helps practicing and learning sight reading, rhythm, technique, playing with both hands and much more!

In addition you will

Progress up in chapters, unlock new songs and raise the difficulty level along the way. Learn to play songs step by step and have access to practice options. You're able to personalize your learning experience.

Piano Method Books Included

Learn songs from some of the most well-known and beloved piano method books used today. A digital way to compliment the use of your favorite method book, all books can be found in the Library in the 'Methods' section. (*IOS-IPAD compatible only!)



SIMPLY PIANO (IOS and ANDROID COMPATIBLE)

Whether you're a complete beginner or want to learn piano on your own, SIMPLY PIANO will guide you to become the piano player you always wanted to be. Just place your IOS or Android device on your piano and play. Your device will immediately recognize what you are playing!

- Learn the piano basics from sight-reading to playing with both hands
- Tons of fun songs ranging from classical to top-charting hits
- Listens to how you play, giving you instant feedback to quickly learn and improve your skills
- Courses for different tastes and levels including pop chords, essentials, blues and more

(* Compatible with both IOS and ANDROID devices)



APPENDIX TIMBRE TABLE

000 Acoustic Grand Piano	035 Fretless Bass	070 Bassoon	105 Banjo
001 Bright Acoustic Piano	036 Slap Bass 1	071 Clarinet	106 Shamisen
002 Electric Grand Piano	037 Slap Bass 2	072 Piccolo	107 Koto
003 Honky-tonk Piano	038 Synth Bass 1	073 Flute	108 Kalimba
004 Rhodes Piano	039 Synth Bass 2	074 Recorder	109 Bagpipe
005 Chorused Piano	040 Violin	075 Pan Flute	110 Fiddle
006 Harpsichord	041 Viola	076 Bottle Blow	111 Shanai
007 Clavichord	042 Cello	077 Shakuhachi	112 Tinkle Bell
008 Celesta	043 Contrabass	078 Whistle	113 Agogo
009 Glockenspiel	044 Tremolo Strings	079 Ocarina	114 Steel Drums
010 Music Box	045 Pizzicato Strings	080 Lead 1 (square)	115 Woodblock
011 Vibraphone	046 Orchestral Harp	081 Lead 2 (sawtooth)	116 Taiko Drum
012 Marimba	047 Timpani	082 Lead 3 (calliope lead)	117 Melodic Tom
013 Xylophone	048 String Ensemble 1	083 Lead 4 (chiff lead)	118 Synth Drum
014 Tubular Bell	049 String Ensemble 2	084 Lead 5 (charang)	119 Reverse Cymbal
015 Dulcimer	050 Synth Strings 1	085 Lead 6 (voice)	120 Guitar Fret Noise
016 Drawbar Organ	051 Synth Strings 2	086 Lead 7 (fifths)	121 Breath Noise
017 Percussive Organ	052 Choir Aahs	087 Lead 8 (bass+lead)	122 Seashore
018 Rock Organ	053 Voice Oohs	088 Pad 1 (new age)	123 Bird Tweet
019 Church Organ	054 Synth Voice	089 Pad 2 (warm)	124 Telephone Ring
020 Reed Organ	055 Orchestra Hit	090 Pad 3 (polysynth)	125 Helicopter
021 Accordion	056 Trumpet	091 Pad 4 (choir)	126 Applause
022 Harmonica	057 Trombone	092 Pad 5 (bowed)	127 Gunshot
023 Tango Accordion	058 Tuba	093 Pad 6 (metallic)	128 Yong Gin
024 Acoustic Guitar (nylon)	059 Muted Trumpet	094 Pad 7 (halo)	129 Zheng
025 Acoustic Guitar (steel)	060 French Horn	095 Pad 8 (sweep)	130 Zhong Ruan
026 Electric Guitar (jazz)	061 Brass Section	096 FX 1 (rain)	131 Pi Pa
027 Electric Guitar (clean)	062 Synth Brass 1	097 FX 2 (soundtrack)	132 Big Souna
028 Electric Guitar (muted)	063 Synth Brass 2	098 FX 3 (crystal)	133 Souna
029 Overdriven Guitar	064 Soprano Sax	099 FX 4 (atmosphere)	134 Er Hu
030 Distortion Guitar	065 Alto Sax	100 FX 5 (brightness)	135 Yue Hu
031 Guitar Harmonics	066 Tenor Sax	101 FX 6 (goblins)	136 Di Zi
032 Acoustic Bass	067 Baritone Sax	102 FX 7 (echoes)	137 Bong Di
033 Electric Bass (finger)	068 Oboe	103 FX 8 (sci-fi)	138 Koto
034 Electric Bass (pick)	069 English Horn	104 Sitar	139 Qu Di

TECHNICAL SPECIFICATION

Power Supply : 100-240VAC 50/60Hz
Weight : 17,60 kg
Dimensions : 1298 x 285 x 112mm

The specifications are typical. The actual values can slightly change from one unit to the other. Specifications can be changed without prior notice.

The products referred to in this manual conform to the European Community Directives to which they are subject:

European Union

Tronios B.V.,
Bedrijvenpark Twente Noord 18,
7602KR Almelo, The Netherlands

2014/35/EU

2014/30/EU

2011/65/EC



United Kingdom

Tronios Ltd.,
130 Harley Street,
London W1G 7JU, United Kingdom

S.I. 2016:1101

S.I. 2016:1091

S.I. 2012:3032



Specifications and design are subject to change without prior notice.

www.tronios.com

Copyright © 2022 by Tronios The Netherlands